



Catellani & Smith®



Lederam C150/180

ceiling

ISTRUZIONI DI MONTAGGIO / ASSEMBLY INSTRUCTIONS / INSTRUCTIONS DE MONTAGE / MONTAGEANLEITUNGEN / INSTRUCCIONES DE MONTAJE

I AVVERTENZE

- Si raccomanda che l'installazione venga eseguita da un elettricista abilitato.
 - Togliere la tensione di alimentazione prima di effettuare l'installazione e per interventi di manutenzione o in caso di cattivo funzionamento.
 - La lampada è fornita di tasselli con bordo di arresto in nylon Ø 6x40 mm per muratura. Si consiglia di verificare la tipologia di tasselli corretta per la vostra parete/soffitto e, se necessario, acquistarli separatamente.
 - Si consiglia l'utilizzo dei guanti in dotazione. Per la pulizia della superficie utilizzare un piumino rimuovi-polvere.
 - La lampada acquistata è garantita se installata e utilizzata nel rispetto delle specifiche del modello. Catellani & Smith declina ogni responsabilità per installazione non appropriata e/o uso diverso da quello indicato.
-  **Rischio di scossa elettrica!** La sorgente luminosa di questo apparecchio deve essere sostituita esclusivamente dal produttore, dal suo servizio di assistenza o da personale qualificato equivalente.

GB WARNINGS

- Only a qualified electrician should execute the installation.
 - Switch off the power supply before installing, servicing or in case of malfunctioning.
 - The lamp is supplied with nylon plugs Ø 6x40 mm for wall mounting. We suggest to check the correct plugs for your type of wall/ceiling and acquire them separately if those included are not suitable.
 - We suggest you to use the gloves provided. We recommend using a feather duster to clean the surfaces.
 - The purchased lamp is guaranteed if installed and used in accordance with to the specifications of the model. Catellani & Smith is not responsible for inappropriate installation of the product and/or a different use than the one indicated.
-  **Risk of electrical shock!** The lighting source of this appliance must be replaced by the manufacturer, by its technical service or by a qualified electrician.

	tensione di rete / voltage	lampadine / bulbs	alimentatore / driver	dimmerazione / dimming
C150	230V	1x 15W scheda LED 230V	-	Triac / IGBT
		1x 15W LED board 230V	-	Triac / IGBT
	110V	1x 14W scheda LED 110V	-	Triac / IGBT
		1x14W LED board 110V	-	Triac / IGBT
C180	230V	1x 25W scheda LED 230V	-	Triac / IGBT
		1x 25W LED board 230V	-	Triac / IGBT
	110V	1x 28W scheda LED 110V	-	Triac / IGBT
		1x 28W LED board 110V	-	Triac / IGBT

GRUPPO DI RISCHIO ESENTE IN ACCORDO ALLA NORMA EN 62471 / RISK EXEMPTION GROUP COMPLIANT WITH EN 62471

REGISTERED COMMUNITY MODEL

I	IP20				
classe class	classe di protezione protection class	persone suggerite per il montaggio people required for mounting		MADE IN ITALY	

UTENSILI INCLUSI / TOOLS SUPPLIED

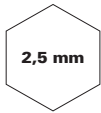

*

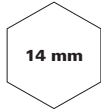

3

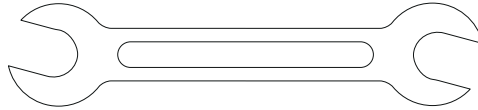

UTENSILI NECESSARI PER MONTAGGIO (NON INCLUSI) / TOOLS REQUIRED FOR MOUNTING (NOT SUPPLIED)

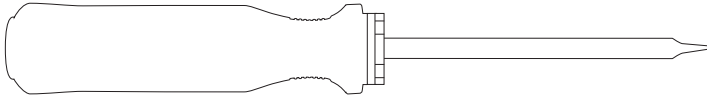

■ Per l'installazione munirsi di cacciavite piatto – punta standard

In order to execute the installation, use a flat-head screwdriver – standard

SI CONSIGLIA DI PROTEGGERE IL BORDO DEL DISCO B PRIMA DI POSIZIONARLO IN VERTICALE PER INSTALLARE L'ASTA, UTILIZZANDO LA CARTA E/O I PARACOLPI IN GOMMAPIUMA FORNITI PER LA SPEDIZIONE.

BEFORE POSITIONING THE DISC B VERTICALLY IN ORDER TO MOUNT THE LED ROD, WE SUGGEST TO PROTECT THE EDGE WITH SOME OF THE PAPER AND/OR THE FOAM BUMPERS SUPPLIED FOR THE DELIVERY.

Lederam C150 / C180

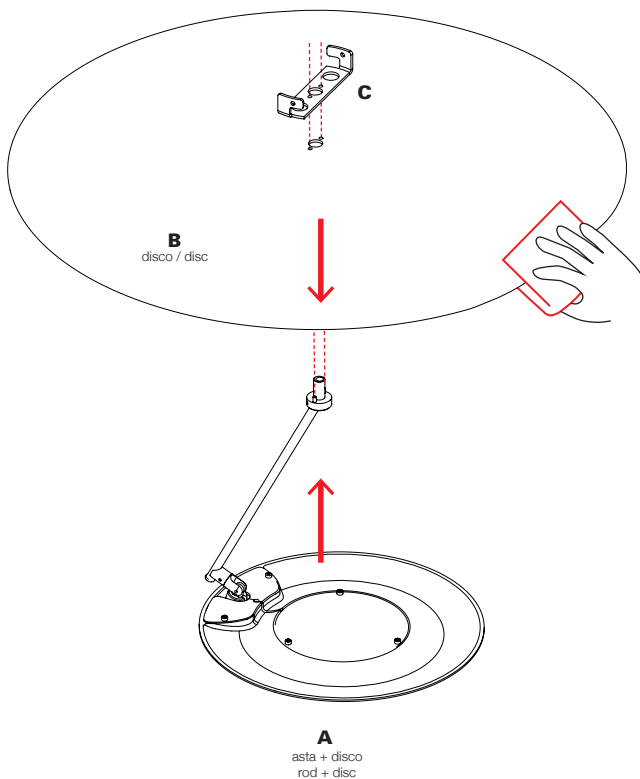

1

B
disco / disc

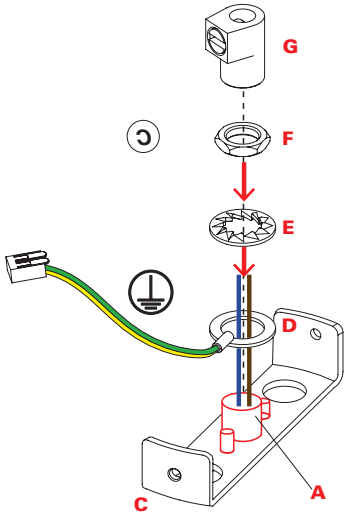

2

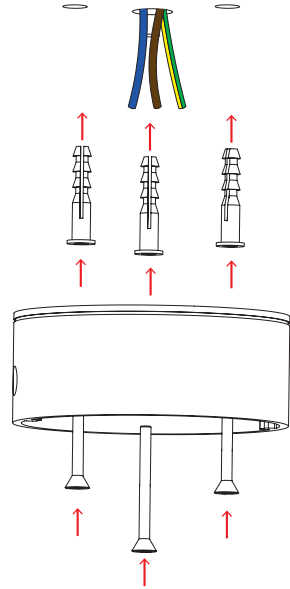

3

PER RAGIONI DI SICUREZZA, SI CONSIGLIA DI SPELARE
IL CAVO PER MAX 7 MM.

FOR SAFETY REASONS WE SUGGEST NOT TO STRIP
THE WIRE MORE THAN 7 MM.

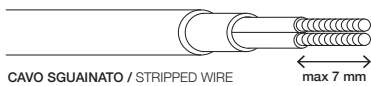

B
disco / disc

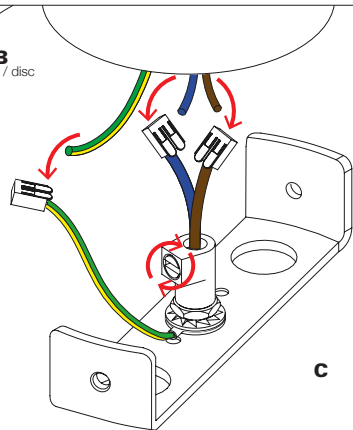

4

—

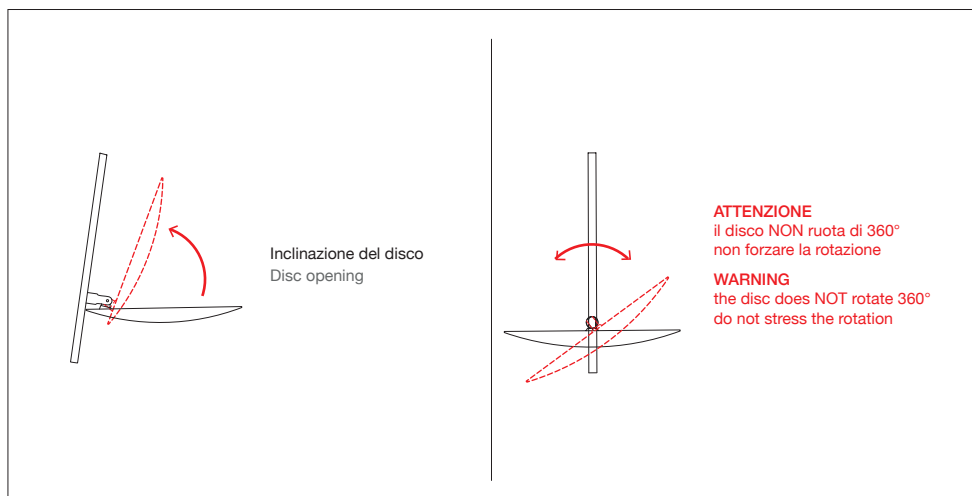
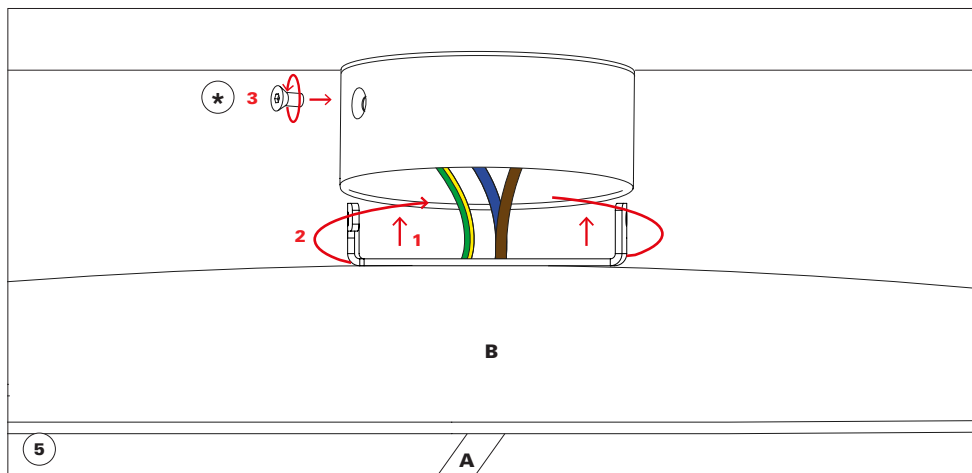

Se lo snodo che regge il disco dovesse allentarsi, si prega di stringere la vite indicata con l'apposita chiave a brugola

In case the joint that supports the disc should loosen, please act on the shown screw by means of the Allen-key supplied

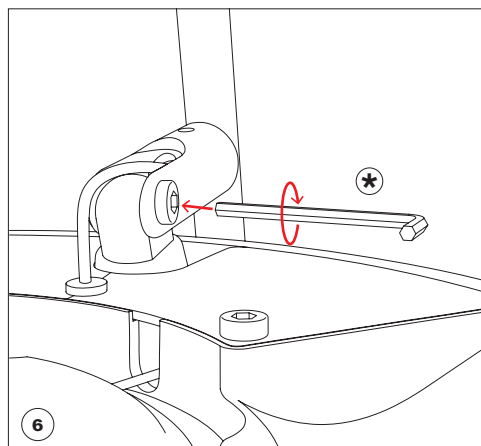

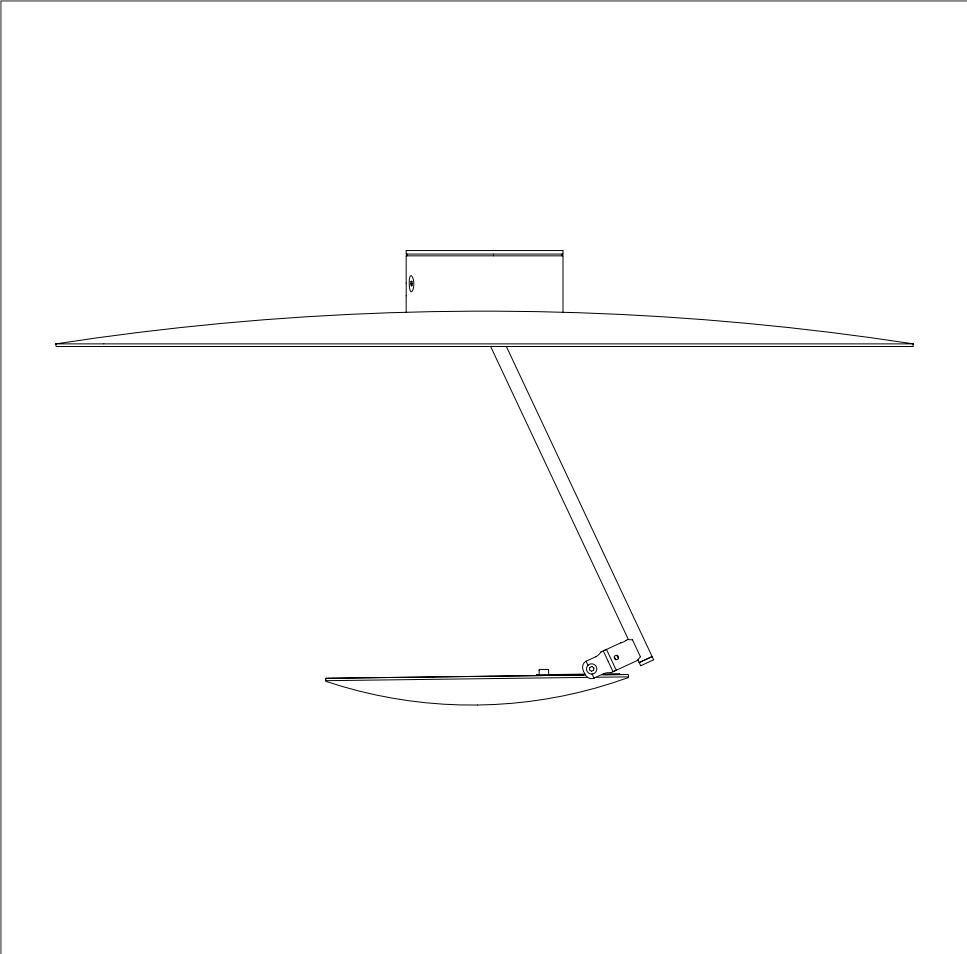



updated 04/2024

Questa apparecchiatura non deve essere smaltita come un normale rifiuto urbano, ma deve essere portata nel punto di raccolta appropriato per il riciclaggio di apparecchiature elettriche ed elettroniche. Provvedendo a smaltire questo prodotto in modo appropriato, si contribuisce ad evitare potenziali conseguenze negative per l'ambiente e per la salute umana, che potrebbero derivare da uno smaltimento inadeguato del prodotto. Per informazioni più dettagliate sul riciclaggio di questo prodotto, contattare l'ufficio comunale, il servizio locale di smaltimento rifiuti o il rivenditore presso il quale è stato acquistato il prodotto.

This equipment may not be treated as household waste. Instead it shall be handed over to the applicable collection point for the recycling of electrical and electronic equipment. By ensuring this product is disposed of correctly, you will help prevent potential negative consequences for the environment and human health, which could otherwise be caused by inappropriate waste handling of this product. For more detailed information about the recycling of this product, please contact your local city office, your household waste disposal or the dealer where you purchased this product.

